



Hi-Rel DC/DC CONVERTER MGDM-150 : 150W POWER

Hi-Rel
Grade ■■■

**5:1 Low Input Voltage : 9-45 & 16-80 VDC
Single Output
Metallic case - 1 500 VDC Isolation**



4

- Ultra wide input range 16-80 Vdc, 9-45 Vdc
- 28Vdc input compliant with MIL-STD-704A/D/F
- Industry standard half brick package
- Power up to 150 W
- Wide temperature range : -40/+105°C baseplate
- High efficiency (typ. 86%-90%)
- Soft start
- Galvanic isolation 1 500 VDC
- Integrated LC EMI filter
- Synchronizable
- Load sharing, N+1 redundancy
- No load to full load operation
- Fully protected by independant security
 - Under & overvoltage lock-out
 - Overvoltage protection
 - Current limitation protection
 - Over temperature protection
- No optocoupler for high reliability
- Leaded process

1-General

The MGDM-150 low input voltage series is a complete line of high density wide input range DC/DC power modules designed for aerospace, military and high-end industrial applications. These modules use a patented fixed switching topology at 420 KHz providing ultra wide input range, low noise characteristics and high power density. Standard models are available with ultra wide input voltage range of 9-45, 16-80 volts. The series include single output voltage choices of 3,3, 5, 12, 15, 24, 28 volts.

The MGDM-150 low input voltage series include synchronization load sharing, trim and sense functions.

The synchronization function allows to synchronize more than one converter to one frequency or an external source frequency. The load sharing allows parallel operation to increase power with a true N+1.

All the modules are designed with LC network filters to minimize reflected input current ripple and output voltage ripple.

The modules have totally independant security functions including input undervoltage and overvoltage lock-out, output overvoltage protection, output current limitation protection, and temperature protection. Additionally a soft-start function allows current limitation and eliminates inrush current during start-up.

The design has been carried out with surface mount components, planar transformer and is manufactured in a fully automated process to guarantee high quality. The modules are potted with a bi-component thermal conductive compound and used an insulated metallic substrate to ensure optimum power dissipation under harsh environmental conditions.

2-Product Selection

Single output model : MGDS - 150 - - / -

Input Voltage Range

Permanent

H : 9-45 VDC
O : 16-80 VDC

Output

B : 3.3 VDC
C : 5 VDC
E : 12 VDC
F : 15 VDC
I : 24 VDC
J : 28 VDC

Options :

/T : option for -55°C start up operating temperature
/S : option for screening and serialization

Suffix :

-L : leaded process

2- Product Selection (continued)

Input range	Output	Current	Reference	Options	Suffix
9-45 VDC	3.3 VDC	30 A	MGDS-150-H-B	/T, /S	-L
9-45 VDC	5 VDC	25 A	MGDS-150-H-C	/T, /S	-L
9-45 VDC	12 VDC	12,5 A	MGDS-150-H-E	/T, /S	-L
9-45 VDC	15 VDC	10 A	MGDS-150-H-F	/T, /S	-L
9-45 VDC	24 VDC	6,25 A	MGDS-150-H-I	/T, /S	-L
9-45 VDC	28 VDC	5,35 A	MGDS-150-H-J	/T, /S	-L
16-80 VDC	3.3 VDC	30 A	MGDS-150-O-B	/T, /S	-L
16-80 VDC	5 VDC	30 A	MGDS-150-O-C	/T, /S	-L
16-80 VDC	12 VDC	12,5 A	MGDS-150-O-E	/T, /S	-L
16-80 VDC	15 VDC	10 A	MGDS-150-O-F	/T, /S	-L
16-80 VDC	24 VDC	6,25 A	MGDS-150-O-I	/T, /S	-L
16-80 VDC	28 VDC	5,35 A	MGDS-150-O-J	/T, /S	-L

4

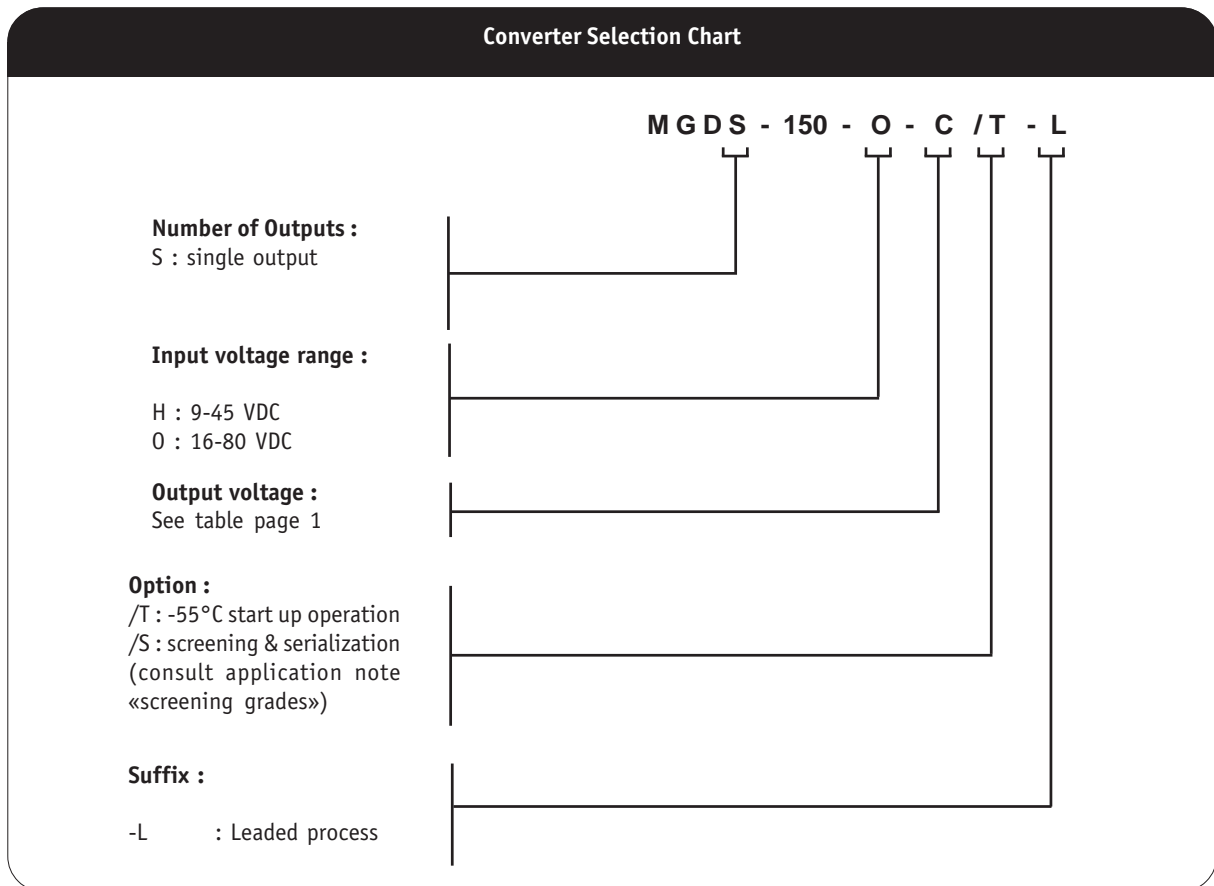

3- Block Diagram

The MGDM-150 low input series DC/DC converter is based on a **constant 420KHz** pulse-width modulated forward topology designed for **ultra large input range**.

The output voltage is monitored on the secondary side avoiding the use of optocoupler to optimize **long-term reliability** and provide good immunity against radiations.

An auxilliary supply is implemented to feed independently all security functions such as the input undervoltage lock-out (UVLO), overvoltage lock-out (OVLO), the output overload protection (OCP), the output overvoltage protection (OVP) and the thermal protection (OTP).

As this auxilliary power is independent from the main power supply, the module features an **extreme wide trim windows from 10% to 110%** of the nominal output voltage.

The main power transformer designed for more than 150W power is a multi-layer planar transformer which allows 100% reproductibility for optimized module efficiencies.

The controlled feedback regulation is located at the secondary side allowing a high regulation bandwidth and a very fast response to load changes.

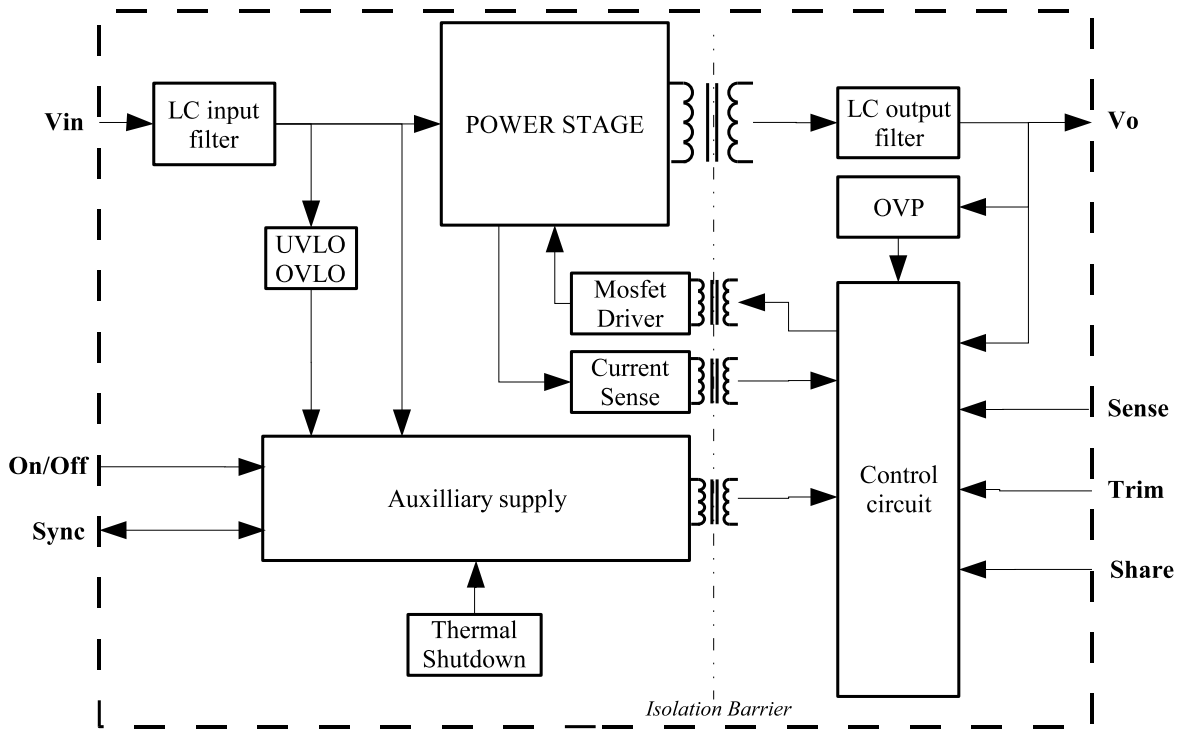

4- Electrical Specifications

Data are valid at +25°C, unless otherwise specified.

Parameter	Conditions	Limit or typical	Units	Single Output MGDS-150		
				150 - H	150 - 0	
Input						
Nominal input voltage	Full temperature range	Nominal	VDC	24	28	
Permanent input voltage range (Ui)	Full temperature range	Min. - Max.	VDC	9 - 45	16 - 80	
Input surge withstand	Above OVLO converter Turns - off	Maximum	VDC/min.	50/1	100/1	
Undervoltage lock-out (UVLO)	Turn-on voltage	Nominal	VDC	8,5	15,5	
	Turn-off voltage	Nominal	VDC	7,5	14,5	
Overvoltage lock-out (OVLO)	Turn-on voltage	Nominal	VDC	45	80	
	Turn-off voltage	Nominal	VDC	46	81	
Start up time	Ui nominal Nominal output Full load : resistive	Maximum	ms	30	30	
Reflected ripple current	Ui nominal, full load BW = 20MHz	Maximum	mApp	200	500	
Input current in short circuit mode (Average)	Ui nominal Short-circuit	Typical	A	1	1	
No load input current	Ui nominal No load	Maximum	mA	30	30	
Input current in inhibit mode	Ui nominal Inhibit	Maximum	mA	15	15	
Output						
Output voltage *	Ui min. to max.	Nominal	VDC	3,3	3,3	
		Nominal	VDC	5	5	
		Nominal	VDC	12	12	
		Nominal	VDC	15	15	
		Nominal	VDC	24	24	
		Nominal	VDC	28	28	
Set Point accuracy *	Ambient temperature : +25°C Ui nominal, 75% load	Maximum	%	+/- 2	+/- 2	
Output power **	At 105°C baseplate Ui min. to max.	Maximum	W	100 to 150	100 to 150	
Output current **	Full temperature range Ui min. to max.	3,3V output	Maximum	A	30	30
		5V output	Maximum	A	25	30
		12V output	Maximum	A	12,5	12,5
		15V output	Maximum	A	10	10
		24V output	Maximum	A	6,25	6,25
		28V output	Maximum	A	5,35	5,35
Ripple output voltage ***	Ui nominal Full load BW = 20MHz	3,3V and 5V output	Typical	mVpp	50	50
		12V output	Typical	mVpp	100	100
		15V output	Typical	mVpp	150	150
		24V and 28V output	Typical	mVpp	250	250
		Output regulation * (Line + load + thermal)	Ui min. to max. 0% to full load	Maximum	%	+/- 1
Output Voltage Trim	As function of output voltage	Minimum	%	10 **	10 **	
		Maximum	%	110	110	
Efficiency	Ui nominal Full load	Typical	%	see curves page 5 and 6		

Note * : These performances are measured with the sense line connected.

Note ** : It is recommended to mount the converter on a heatsink for this test, see section 10-3 and 10-9 for further details.

Note *** : The ripple output voltage is the periodic AC component imposed on the output voltage, an aperiodic and random component (noise) has also to be considered. It is recommended to add 4 external decoupling capacitors (typically 10nF) connected between inputs and case and between outputs and case. These capacitance should be layed-out as close as possible from the converter.

4- Electrical Characteristics (continued)

MGDS-150-H-B - Efficiency vs Output Power

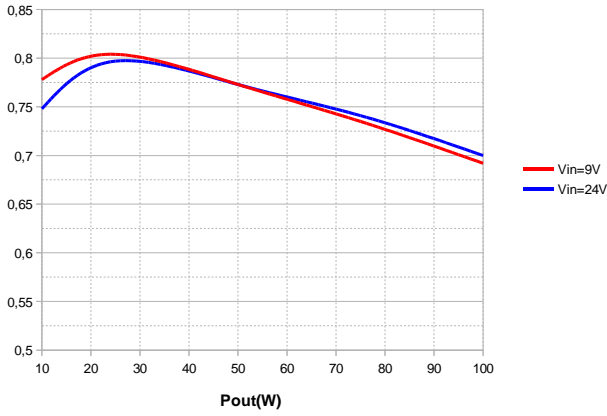

MGDS-150-H-C - Efficiency vs Output Power

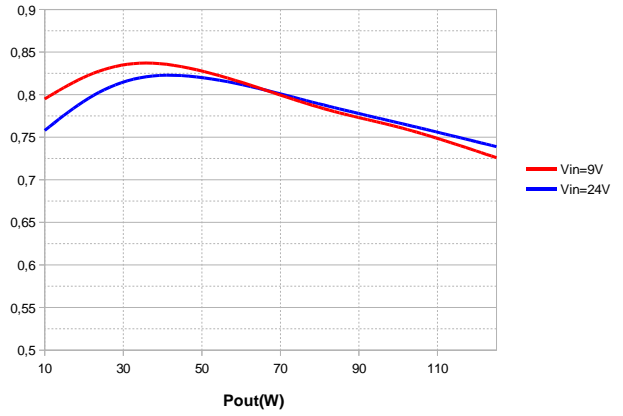

MGDS-150-H-E - Efficiency vs Output Power

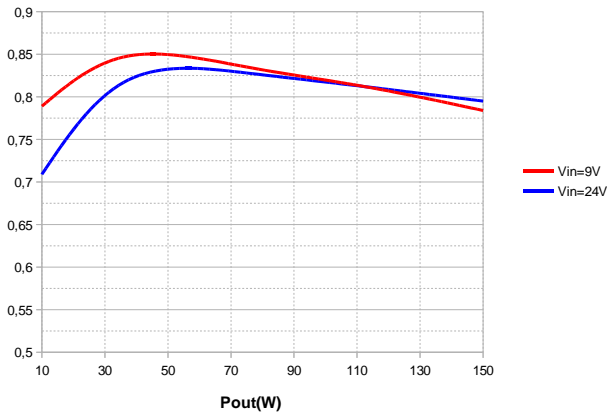

MGDS-150-H-F - Efficiency vs Output Power

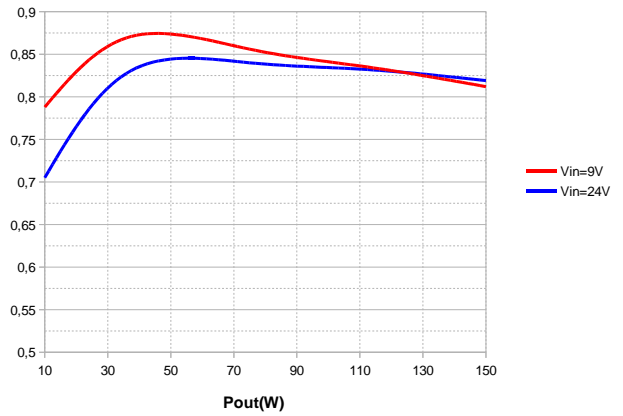

MGDS-150-H-I - Efficiency vs Output Power

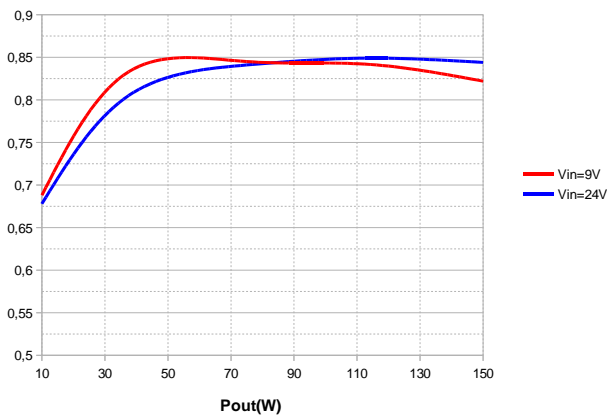

MGDS-150-H-J - Efficiency vs Output Power

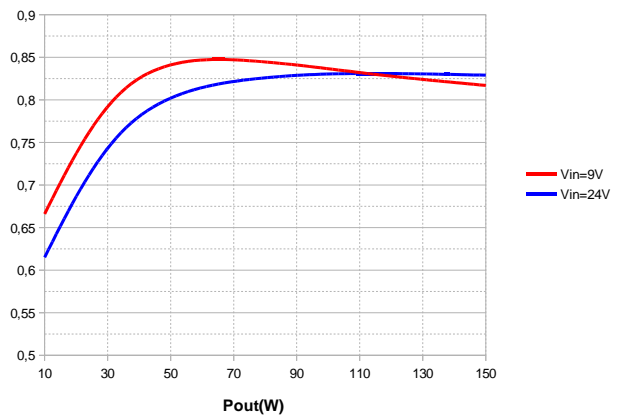

4

4- Electrical Characteristics (continued)

MGDS150-O-B - Efficiency vs Output Power

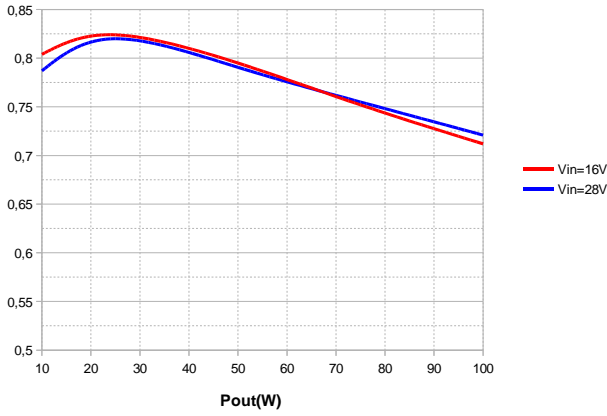

MGDS-150-O-C - Efficiency vs Output Power

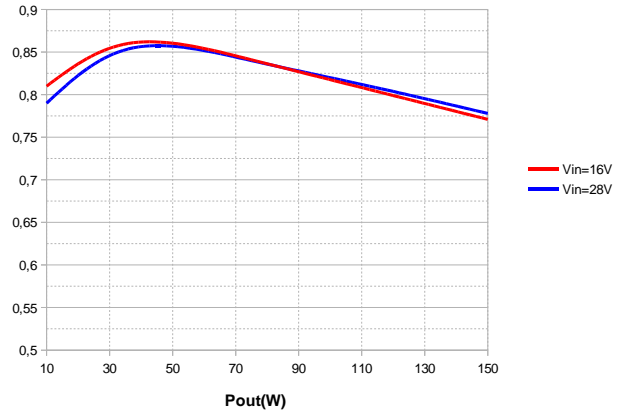

MGDS-150-O-E - Efficiency vs Output Power

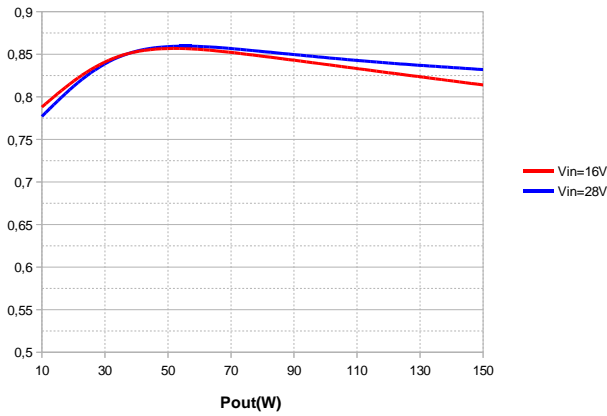

MGDS-150-O-F - Efficiency vs Output Power

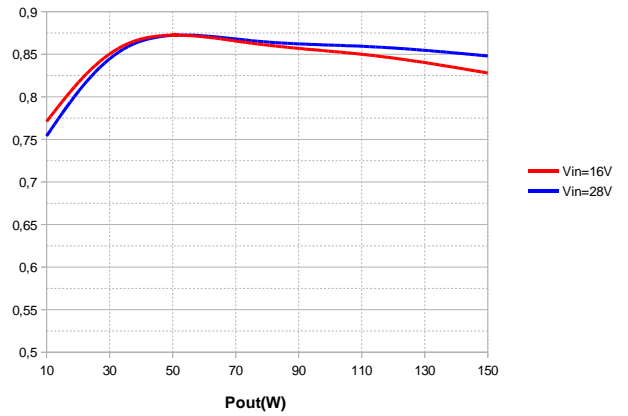

MGDS-150-O-I - Efficiency vs Output Power

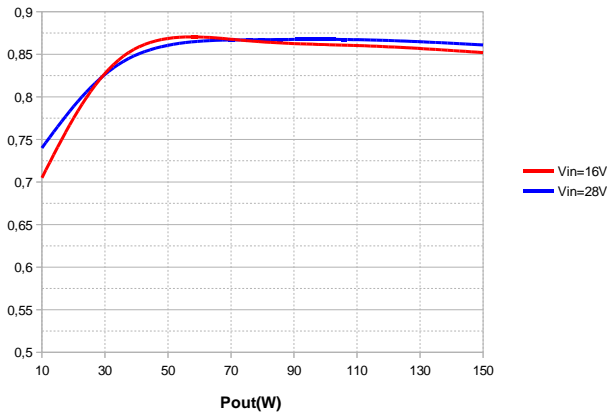

MGDS-150-O-J - Efficiency vs Output Power

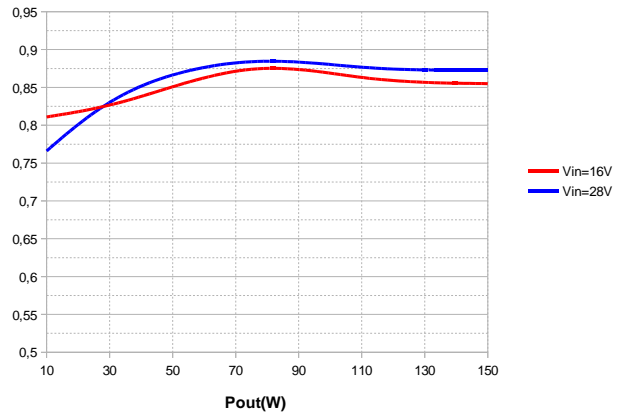

4

5- Switching Frequency

Parameter	Conditions	Limit or typical	Specifications
Switching frequency	Full temperature range Ui min. to max. No load to full load	Nominal, fixed	420 KHz

6- Isolation

Parameter	Conditions	Limit or typical	Specifications
Electric strength test voltage	Input to output	Minimum	1 500 VDC / 1 min
	Input to case	Minimum	1 500 VDC / 1 min
	Output to case	Minimum	1 500 VDC / 1 min
Isolation resistance	500 VDC	Minimum	100 M0hm

7- Protection Functions

Characteristics	Protection Device	Recovery	Limit or typical	Specifications
Input undervoltage lock-out (UVLO)	Turn-on, turn-off circuit with hysteresis cycle	Automatic recovery	Turn-on nominal Turn-off nominal	See section 4
Input overvoltage lock-out (OVLO)	Turn-on, turn-off circuit with hysteresis cycle	Automatic recovery	Turn-on nominal Turn-off nominal	See section 4
Output current limitation protection (OCP)	Foldback current limitation	Automatic recovery	Maximum	110% of output current
Output overvoltage protection (OVP)	Overvoltage protection device with latch-up	Resettable	Typical	115% to 135% of output voltage
Over temperature protection (OTP)	Thermal device with hysteresis cycle	Automatic recovery	Maximum	115°C

8- Reliability Data

Characteristics	Conditions	Temperature	Specifications
Mean Time Between Failure (MTBF) According to MIL-HDBK-217F	Ground fixed (Gf)	Case at 40°C Case at 85°C	400 000 Hrs 130 000 Hrs
	Airborne, Inhabited, Cargo (AIC)	Case at 40°C Case at 85°C	225 000 Hrs 82 000 Hrs
Mean Time Between Failure (MTBF) According to IEC-62380-TR	Civilian avionics, calculators	Ambient at 55°C 100% time on	360 000 Hrs

9- Electromagnetic Interference

Electromagnetic Interference requirements according to MIL-STD-461C/D/E standards can be easily achieved as indicated in the following section. The following table resumes the different sections covered by these standards.

Standard Requirements	MIL-STD-461C Standard	MIL-STD-461D/E Standard	Compliance with GAIA Converter Module & common mode capacitance
Conducted emission (CE) : Low frequency High frequency	CE 01 CE 03	CE 101 CE 102	compliant module stand-alone compliant with additional filter
Conducted susceptibility (CS) : Low frequency High frequency	CS 01 CS 02	CS 101 CS114	compliant with additional filter compliant with additional filter
Radiated emission (RE) : Magnetic field Electrical field	RE 01 RE 02	RE 101 RE 102	compliant module stand-alone compliant module stand-alone
Radiated susceptibility (RS) : Magnetic field Electrical field	RS 01 RS 03	RS 101 RS 103	compliant module stand-alone compliant module stand-alone

4

9-1 Module Compliance with MIL-STD-461C/D/E Standards

To meet the latest US military standards MIL-STD-461D/E (and also the MIL-STD-461C) requirements and in particular the conducted noise emission CE102 (and also CE03) requirements, Gaia Converter can propose a stand-alone ready-to-use EMI filter module. This EMI filter module has to be used together with 4 external decoupling capacitance C_c (10nF/rated voltage depending on isolation requirement) connected between input and case and output and case.

EMI filter module reference : FGDS-10A-50V or FGDS-20A-50V.
Please consult EMI filter datasheet for further details.

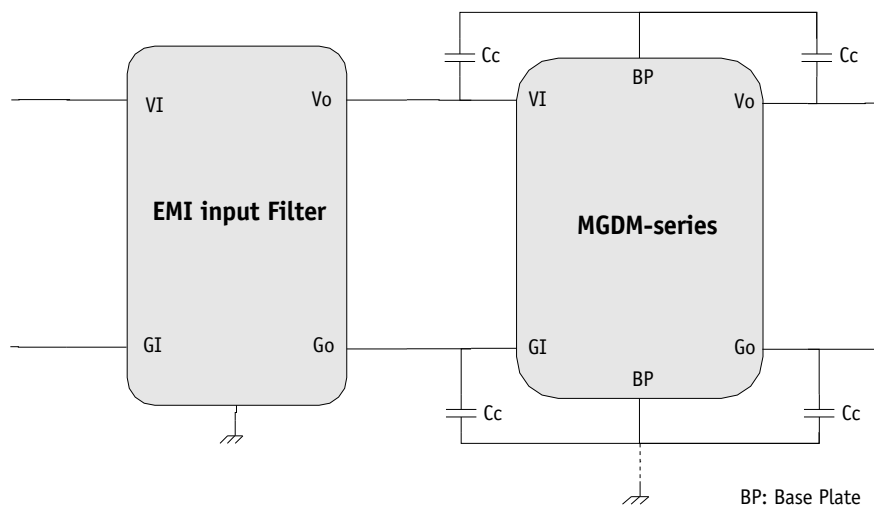

10- Thermal Characteristics

Characteristics	Conditions	Limit or typical	Performances
Operating ambient temperature range at full load	Ambient temperature *	Minimum Maximum	- 40°C see below
Baseplate temperature	Base plate temperature	Minimum Maximum	- 40°C + 105°C
Storage temperature range	Non fonctionning	Minimum Maximum	- 55°C + 125°C
Thermal resistance	Baseplate to ambient Rth(b-a) free air	Typical	8°C/W

Note * : The upper temperature range depends on configuration, the user must ensure a max. baseplate temperature of + 105°C.

The following discussion will help designer to determine the thermal characteristics and the operating temperature.

The MGDM-150 low input series maximum **baseplate** temperature at full load must not exceed 105°C. Heat can be removed from the baseplate via three basic mechanisms :

- Radiation transfert : radiation is counting for less than 5% of total heat transfert in majority of case, for this reason the presence of radiant cooling is used as a safety margin and is not considered.
- Conduction transfert : in most of the applications, heat will be conducted from the baseplate into an attached heatsink or heat conducting member; heat is conducted thru the interface.
- Convection transfert : convecting heat transfer into air refers to still air or forced air cooling.

In majority of the applications, heat will be removed from the baseplate either with :

- heatsink,
- forced air cooling,
- both heatsink and forced air cooling.

The table hereafter gives some example of thermal resistance for different heat transfert configurations.

Heat transfert	Thermal resistance heatsink to air Rth(h-a)	Thermal resistance baseplate to heatsink Rth(b-h)	Global resistance
Free air cooling only	No Heatsink baseplate only : 8°C/W	No need of thermal pad	8°C/W
	Heatsink Thermalloy 6516B : 4,4°C/W	Bergquist Silpad* : 0,14°C/W	4,54°C/W
	Heatsink Fischer Elektronik SK DC 5159SA : 3,8°C/W	Bergquist Silpad* : 0,14°C/W	3,94°C/W
Forced air cooling 200 LFM	No Heatsink baseplate only : 4,5°C/W	No need of thermal pad	4,5°C/W
	Heatsink Thermalloy 6516B : 3°C/W	Bergquist Silpad* : 0,14°C/W	3,14°C/W
	Heatsink Fischer Elektronik SK DC 5159SA : 2,5°C/W	Bergquist Silpad* : 0,14°C/W	2,64°C/W
Forced air cooling 400 LFM	No Heatsink baseplate only : 3,2°C/W	No need of thermal pad	3,2°C/W
	Heatsink Thermalloy 6516B : 1,75°C/W	Bergquist Silpad* : 0,14°C/W	1,89°C/W
	Heatsink Fischer Elektronik SK DC 5159SA : 1,7°C/W	Bergquist Silpad* : 0,14°C/W	1,84°C/W
Forced air cooling 1000 LFM	No Heatsink baseplate only : 1,7°C/W	No need of thermal pad	1,7°C/W
	Heatsink Fischer Elektronik SK DC 5159SA : 0,9°C/W	Bergquist Silpad* : 0,14°C/W	1,04°C/W

Fischer Elektronik and Thermalloy are heatsink manufacturers. «Silpad»® is a registered trademark of Bergquist.

Note * : Silpad performance are for Silpad 400 with pressure conditions of 50 Psi. Surface of MGDS-150 series is 5,5 inch2.

To calculate a maximum admissible ambient temperature the following method can be used.

Knowing the maximum baseplate temperature Tbase = 105°C of the module, the power used Pout and the efficiency η :

- determine the power dissipated by the module P_{diss} that should be evacuated :

$$P_{diss} = P_{out}(1/\eta - 1) \quad (A)$$

- determine the maximum ambient temperature :

$$T_a = 105^\circ\text{C} - R_{th}(b-a) \times P_{diss} \quad (B)$$

where **Rth(b-a)** is the thermal resistance from the baseplate to ambient.

This thermal Rth(b-a) resistance is the summ of :

- **the thermal resistance of baseplate to heatsink (Rth(b-h))**. The interface between baseplate and heatsink can be nothing or a conducting member, a thermal compound, a thermal pad.... The value of Rth(b-h) can range from 0.4°C/W for no interface down to 0.1°C/W for a thermal conductive member interface.
- **the thermal resistance of heatsink to ambient air (Rth(h-a))**, which is depending of air flow and given by heatsink supplier.

9- Thermal Characteristics (continued) : Heatsink Mounting

To mount properly the module to heatsink, some important recommendations need to be taken into account in order to avoid overstressing conditions that might lead to premature failures.

The module case is built with a copper IMS (isolated metallic substrate) crimped on an aluminum frame that provides case rigidity. The IMS surface is the module base plate that need to be reported to heat sink to achieve proper cooling. If for some reasons like poor module report, the IMS base plate is subject to mechanical overstress, module's electrical characteristics may be definitely affected.

A typical example of damageable report is the use of thick thermal interface with usual screwing torque applied on mounting screws. This combination causes a high pressure on baseplate center due to thermal interface material compression. The final consequence is a slight IMS bending that can conduct for the module to fail high voltage isolation leading to heavy electrical damage on internal circuit.

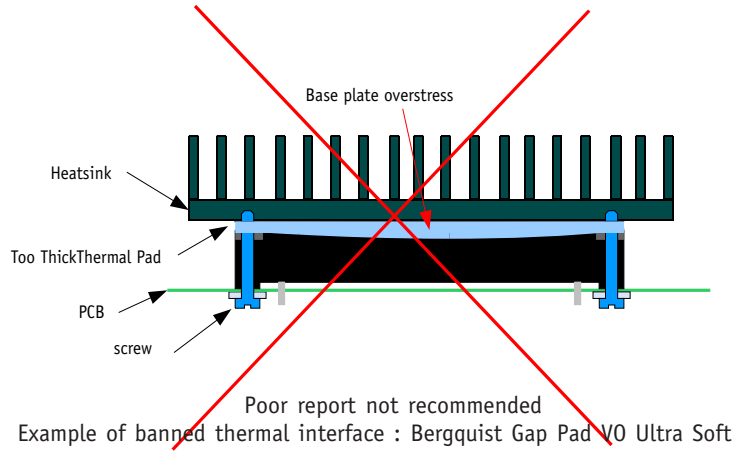

The good practice is to respect the 4 following recommendations:

- do not exceed recommended screwing torque of 0,7 N.m (6 lbs.in)
 - prefer thin thermal pad with thickness lower than 0,34 mm (0.015").
- GAIA Converter recommends to use thin thermal pads instead of thermal compound like grease.
- take care to reflow module leads only when all assembly operations are completed.
 - do not report module on surfaces with poor flatness characteristics. GAIA Converter recommends not to overflow 0,1mm/m for the surface flatness.

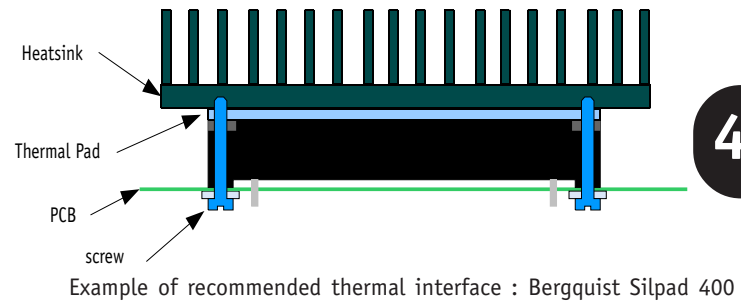

4

Gaia converter suggests to follow the procedure hereunder for the mechanical assembly procedure in order to avoid any stress on the pins of the converters. It is good practice to be sure to mount the converters first mechanically, then solder the units in place.

1. Choice of the thermal gap pad : its shape must be the same as the module. The dimensions of the gap pad can be a little larger than the module.
2. Screw the converter to the heatsink and/or to the board. The four screws have to be screwed in a "X" sequence.
 - Lightly finger-tighten all screws and run several «X» sequences before achieving final torque to get homogeneous tightening.
 - Torque screws from 0,35 N.m (3 lbs.in) to 0,7 N.m (6 lbs.in).
3. Screw the heatsink to the board.
4. Solder the pins of the converters on the board. This sequence avoids mechanical stresses on the converters that could lead to stress internal components or assemblies and cause their failures.

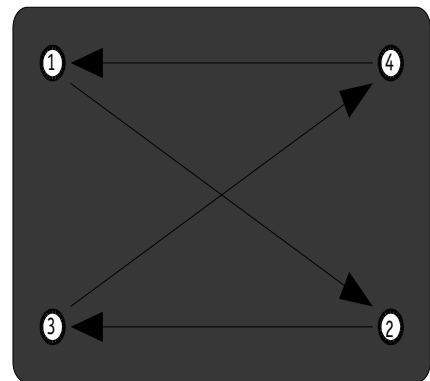

11- Environmental Qualifications

The modules have been subjected to the following environmental qualifications.

Characteristics	Conditions	Severity	Test procedure
Climatic Qualifications			
Life at high temperature	Duration Temperature / status of unit	Test D : 1 000 Hrs @ 105°C case, unit operating @ 125°C ambient, unit not operating	MIL-STD-202G Method 108A
Altitude	Altitude level C Duration Climb up Stabilization Status of unit	40 000 ft@-55°C 30 min. 1 000 ft/min to 70 000 ft@-55°C, 30 min. unit operating	MIL-STD-810E Method 500.3
Humidity cyclic	Number of cycle Cycle duration Relative humidity variation Temperature variation Status of unit	10 Cycle I : 24 Hrs 60 % to 88 % 31°C to 41°C unit not operating	MIL-STD-810E Method 507.3
Humidity steady	Damp heat Temperature Duration Status of unit	93 % relative humidity 40°C 56 days unit not operating	MIL-STD-202G Method 103B
Salt atmosphere	Temperature Concentration NaCl Duration Status of unit	35°C 5 % 48 Hrs unit not operating	MIL-STD-810E Method 509.3
Temperature cycling	Number of cycles Temperature change Transfert time Steady state time Status of unit	200 -40°C / +85°C 40 min. 20 min. unit operating	MIL-STD-202A Method 102A
Temperature shock	Number of shocks Temperature change Transfert time Steady state time Status of unit	100 -55°C / +105°C 10 sec. 20 min. unit not operating	MIL-STD-202G Method 107G
Mechanical Qualifications			
Vibration (Sinusoidal)	Number of cycles Frequency / amplitude Frequency / acceleration Duration Status of unit	10 cycles in each axis 10 to 60 Hz / 0.7 mm 60 to 2 000 Hz / 10 g 2h 30 min. per axis unit not operating	MIL-STD-810D Method 514.3
Shock (Half sinus)	Number of shocks Peak acceleration Duration Shock form Status of unit	3 shocks in each axis 100 g 6 ms 1/2 sinusoidal unit not operating	MIL-STD-810D Method 516.3
Bump (Half sinus)	Number of bumps Peak acceleration Duration Status of unit	2 000 Bumps in each axis 40 g 6 ms unit not operating	MIL-STD-810D Method 516.3

12- Description of Protections

The MGDM-150 low input series include 5 types of protection devices that are powered and controlled by a fully independent side power stage.

12-1 Input Undervoltage Lockout (UVLO) and Overvoltage Lockout (OVLO)

12-1-1 Undervoltage Lockout (UVLO)

An undervoltage protection is implemented to lock off the converter as long as the input voltage has not reached the UVLO turn-on threshold (see section 4 for value) which is the minimum input voltage required to operate without damaging the converter.

12-1-2 Overvoltage Lockout (OVLO)

An overvoltage protection will inhibit the module when input voltage reaches the overvoltage lockout turn-off threshold (see section 4 for value) and restores to normal operation automatically when the input voltage drops below the overvoltage Lockout turn on threshold.

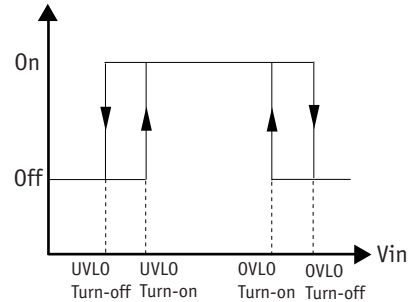

12-2 Output Over Current Protection (OCP)

The MGDM-150 low input series incorporates a foldback current limit and protection circuit. When the output current reaches 110% of its full-rated current ($I_{current\ limit}$), the output voltage falls and output current falls along the foldback line as described in the figure herein. The module restart automatically to normal operation when overcurrent is removed.

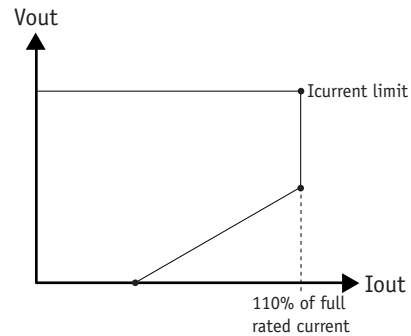

12-3 Output Overvoltage Protection (OVP)

Each circuit has an internal overvoltage protection circuit that monitors the voltage across the output power terminals. It is designed to latch the converter off at 115% to 135% of output voltage.

Once in OVP protection, the module will restart with the On/Off function or with the input bus restart.

12-4 Over Temperature Protection (OTP)

A thermal protection device adjusted at 115°C (+/-5%) internal temperature with 10°C hysteresis cycle will inhibit the module as long as the overheat is present and restores to normal operation automatically when overheat is removed. The efficiency of the OTP function is warranty with the module mounted on a heatsink.

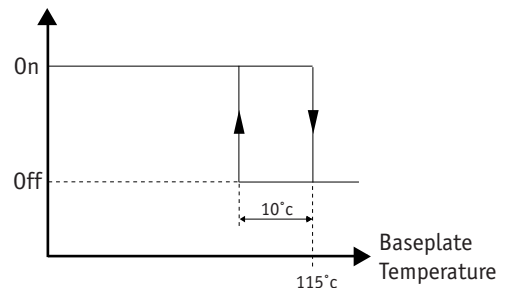

13- Description of Functions

13-1 Trim Function

The output voltage V_o may be trimmed in a range of 10%/110% of the nominal output voltage via a single external trimpot or fixed resistor.

Trim Up Function

Do not attempt to trim the module higher than 110% of nominal output voltage as the overvoltage protection may occur.

Also do not exceed the maximum rated output power when the module is trimmed up.

The trim up resistor must be connected to S+ pin.

The trim up resistance must be calculated with the following formula :

$$R_u = \frac{R_1 \times (V_o - V_{ref}) \times V_{0nom}}{(V_o - V_{0nom}) \times V_{ref}} - R_1 - R_2$$

Note : This formula is a reduced form of the real expression that gives an approached value. To get an accurate value, please use the trim calculator in our web site at www.gaia-converter.com/calculator.trimcalculation.php

Trim Down Function

Do not trim down more than -90% of nominal output voltage or 1 Vdc.

The available output power is reduced by the same percentage that output voltage is trimmed down.

The trim down resistor must be connected to S- pin.

The trim down resistance must be calculated with the following formula :

$$R_d = \frac{(R_2 + R_1) \times V_o - (R_2 \times V_{0nom})}{V_{0nom} - V_o}$$

Note : This formula is a reduced form of the real expression that gives an approached value. To get an accurate value, please use the trim calculator in our web site at www.gaia-converter.com/calculator.trimcalculation.php

Trim via a voltage

The output voltage is given by the following formula :

$$V_o = \left(1 + \frac{R_1}{R_1 + R_2}\right) \times \frac{V_{control}}{V_{ref}} \times V_{0nom}$$

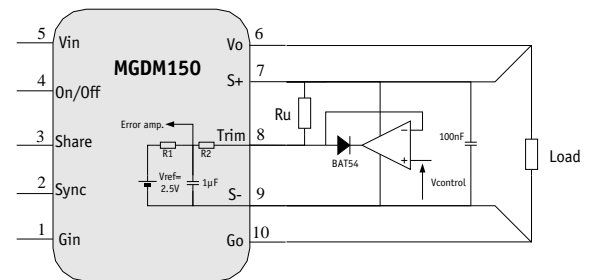
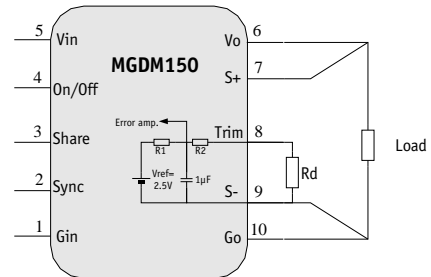
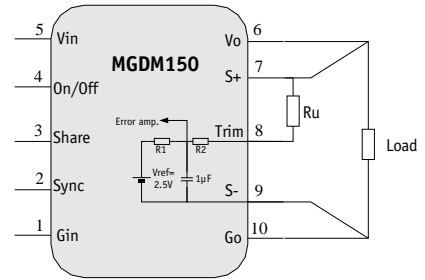

Parameter	Unit	Min.	Typ.	Max.
Trim reference	Vdc	2,45	2,5	2,55
Resistor R1	Ohm	/	3800	/
Resistor R2	Ohm	/	270	/
Trim capacitor	µF	/	1	/

13- Description of Functions (continued)

13-2 Sense Function

If the load is separated from the output by any line length, some of these performance characteristics will be degraded at the load terminals by an amount proportional to the impedance of the load leads. Sense connections enable to compensate the line drop at a maximum of +/-10% of output voltage. The overvoltage protection will be activated and module will shut down if remote sense tries to boost output voltage above 110% of nominal output voltage. Connection is described in figure herein.

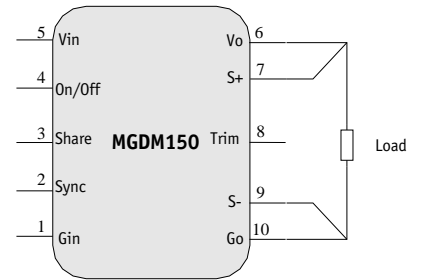

13-3 On/Off Function

The control pin 4 (On/Off) can be used for applications requiring On/Off operation. This may be done with an open collector transistor, a switch, a relay or an optocoupler. Several converters may be disabled with a single switch by connecting all

On/Off pins together.

- The converter is disabled by pulling low the pin 4.
- No connection or high impedance on pin 4 enables the converter.

By releasing the On/Off function, the converter will restart within the start up time specifications given in table section 4. For further details please consult "Logic On/Off" application note.

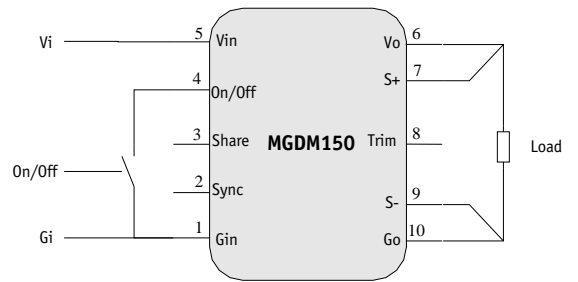

Parameter	Unit	Min.	Typ.	Max.	Notes, conditions
On/Off module enable voltage	Vdc	3.5	/	4	Open, the switch must not sink more than 100µA
On/Off module disable voltage	Vdc	0	/	0.5	The switch must be able to sink 1mA
On/Off alarm level	Vdc	0	/	0.5	UVLO, OVLO, OVP, OTP, faulty module
On/Off module enable delay	ms	/	/	30	The module restarts with the same delay after alarm mode removed
On/Off module disable delay	µs	/	/	100	Vi nominal, full load

13-4 Synchronization Function

An external clock with rectangular «Pull Up» signals can be used to lock one or more converters. The external clock signal should have a frequency range from 860KHz to 940KHz, a low level below 0,5V a high level of 4V (+/-0.5V), a rise time of 30 ns max. and a drop time of 100ns max.

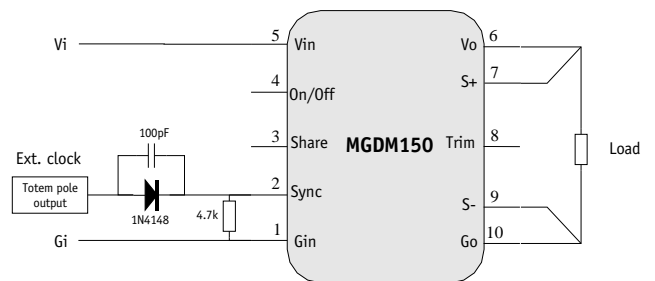
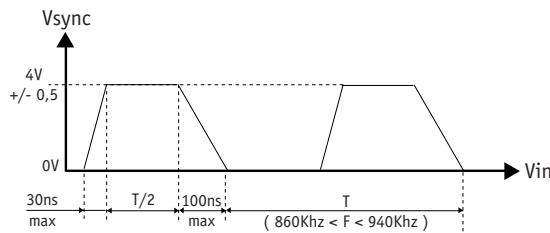

14- Application Notes

14-1 Synchronization of Modules

The MGDM-150 low input series provides a synchronization function through the pin 2 (Synchro) to enable automatic synchronization between several converters.

If several converters are used, they lock themselves into the highest switching frequency.

The synchronization signal available on pin 2 is referenced to ground (Gi) and the signal shape is the double of the switching frequency (i.e. 2x420KHz). It is a rectangular signal with 3.5 Vp (+/-0.5V) amplitude with an impedance of 4,7 KOhm on low level.

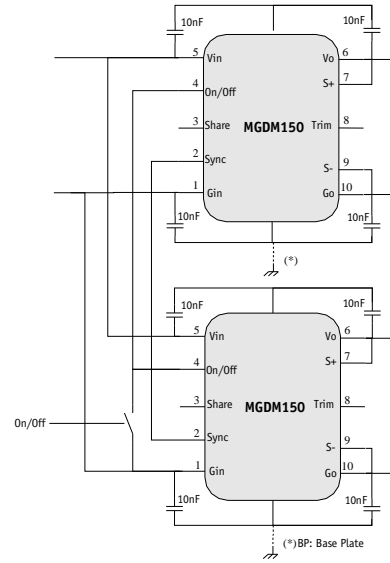

14-2 Connection of Modules in Series

The output of single output units can be connected in series without any precautions to provide higher output voltage level.

Nevertheless, GAIA Converter recommends to protect each individual output by a low power shottky diode rated with the maximum current of the converter to avoid reverse polarity at any output.

Reverse polarity may occur at start up if the output voltages do not rise at the same time.

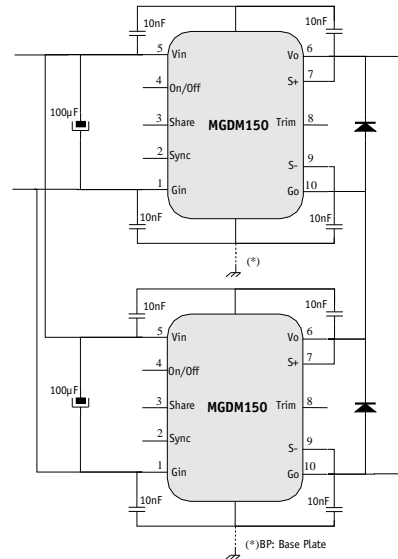

14-3 Connection of Modules in Parallel

The MGDM-150 low input series features a «parallel operation function» to increase the output power capability of a single unit by connecting the outputs of 2 or more converters in parallel. By connecting the «Share» pin of each module together, the units will share the load current equally within a few percent. Up to 5 converters can be parallelized.

The «Share» signal is a DC voltage which varies between 0Vdc and 5Vdc referenced to «Sense -» and depending on the output load.

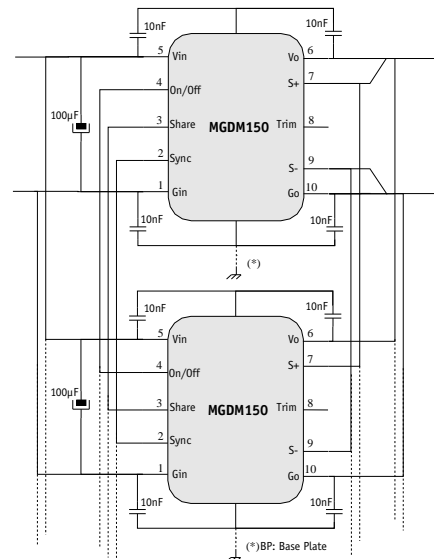

15- Dimensions

Dimensions are given in mm (inches). Tolerance : +/- 0,2 mm (+/- 0.01 ") unless otherwise indicated.
Weight : 110 grams (3,9 Ozs) max.

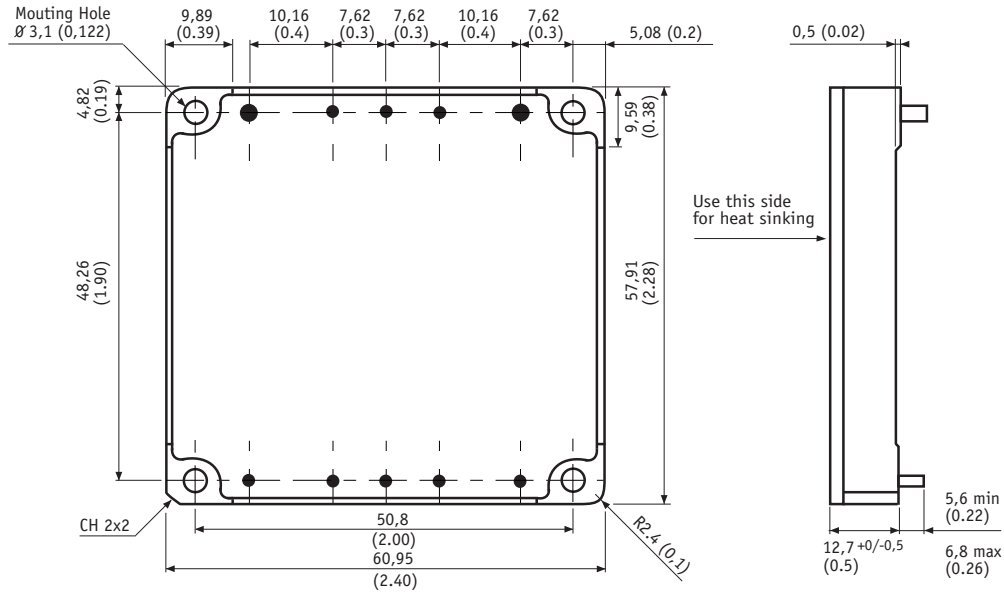

Pin dimensions :

Pins : 1, 2, 3, 4, 5, 7, 8, 9 : Ø 1 mm (0.04")

Pins : 6, 10 : Ø 2 mm (0.08")

16- Materials

Frame : Aluminium alodined coating.

Baseplate : Copper with tin finishing.

Pins : Plated with pure matte tin over nickel underplate.

17- Product Marking

Side face : Company logo.

: Module reference : MGDx-150-»X»-»Y».

Date code : year and week of manufacturing, suffix, /option.

18- Connections

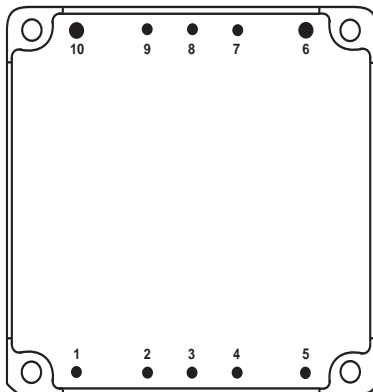

Bottom view

Pin	Single Output
1	- Input (Gi)
2	Syncro (Sync)
3	Share
4	On/Off
5	+ Input (Vi)
6	+ Output (Vo)
7	Sense + (S+)
8	Trim (Trim)
9	Sense - (S-)
10	- Output (Go)



For more detailed specifications and applications information, contact :

International Headquarters

GAIA Converter - France
ZI de la Morandière
33185 LE HAILLAN - FRANCE
Tel. : + (33)-5-57-92-12-80
Fax : + (33)-5-57-92-12-89

North American Headquarters

GAIA Converter Canada, Inc
4038 Le Corbusier Blvd
LAVAL, QUEBEC - CANADA H7L 5R2
Tel. : (514)-333-3169
Fax : (514)-333-4519

Represented by :